

# *Migali*

COMPETITOR SERIES



## INSTRUCTION MANUAL

### Reach-In Refrigerators & Freezers

Migali Foodservice Refrigeration  
Call Toll Free: 800.852.5292



## **Content:**

1.Preface.....	2
2.Use of the equipment.....	5
3.Technical features.....	5
4.Operation.....	5
5.Control unit.....	6
6.Handling.....	6
7.Installation procedure.....	7
8.Connecting to the main power supply.....	7
9.Maintenance instructions.....	8
Cleaning.....	8
Cleaning the refrigerator surface.....	8
Cleaning the inside of the refrigerator.....	9
Cleaning the condenser.....	9
10.Troubleshooting.....	9
11.Technical service.....	9
12.Configuration Sketch Map.....	10
Operating Instruction.....	10
Electrical Control Circuit Diagram.....	13
Technical Parameters.....	15
Official Approval And Rules.....	17



## 1. Preface

Please read instructions before using this appliance.

### IMPORTANT SAFETY INSTRUCTION

- ▲ To reduce the risk of fire, electric shock, or injury to persons when using your product, basic safety precautions should be followed, including the following.
- ▲ This appliance must be properly installed and located in accordance with the Installation Instruction before it is used.
- ▲ Before the appliance is plugged in, ensure that the rated voltage corresponds to the voltage of the electrical system in your home. The power plug should have its own independent socket. Using adapters may cause overheating or burning.
- ▲ This appliance can be used by children aged from 8 years and above and persons with reduced physical, sensory or mental capabilities or lack of experience and knowledge if they have been given supervision or instruction concerning use of the appliance in a safe way and understand the hazards involved.
- ▲ Children shall not play with the appliance.
- ▲ Cleaning and user maintenance shall not be made by children without supervision.
- ▲ If the supply cord is damaged, it must be replaced by the manufacturer or its service agent or a similarly qualified person in order to avoid a hazard.
- ▲ Connect to properly grounded outlets only. Avoid the use of extension cords. Do not run cord under carpeting, runners or the like. Arrange cord away from traffic area and where it will not create a tripping hazard.
- ▲ Always unplug appliance when not in use and before cleaning, adjusting or maintaining this machine. To disconnect appliance, turn switch off and remove plug from power source.



- ▲ Do not disconnect by pulling on the cord. Always disconnect by grasping and pulling on the plug top.
- ▲ Do not pull out the cord or touch the power plug with wet hands. Clean water or dust from the power plug and insert it with the ends of the pins securely connected.
- ▲ Do not use outdoors.
- ▲ Do not splash water on the appliance. It may cause a malfunction or electric shock.
- ▲ Do not disassemble, repair or alter the appliance. It may cause fire or abnormal operations, which may lead to injury.
- ▲ After your fridge-freezer is in operation, do not touch the cold surfaces in the freezer compartment, particularly when hands are damp or wet. Skin may adhere to these extremely cold surfaces.
- ▲ Never place glass products in the freezer because they may be broken when their inner contents are frozen.
- ▲ The refrigerant and insulation blowing gas used in the appliance require special disposal procedures. When disposal, please consult with service agent or a similarly qualified person.
- ▲ Do not store explosive substances such as aerosol cans with a flammable propellant in this appliance.
- ▲ **WARNING:** Keep clear of obstruction all ventilation openings in the appliance enclosure or in the structure for building-in.
- ▲ **WARNING:** Do not use mechanical devices or other means to accelerate the defrosting process, other than those recommended by the manufacturer.
- ▲ **WARNING:** Do not damage the refrigerant circuit.
- ▲ **WARNING:** Do not use electrical appliances inside the food storage compartments of the appliance, unless they are of the type recommended by the manufacturer.



**Warning: Risk of fire / flammable materials**

**CAUTION: RISK OF FIRE AND EXPLOSION WITH FLAMMABLE REFRIGERANT R290.**

▲ If you need the electronic version instruction manual, please ask the manufacturer or its service agent .

▲ Max. Load of shelf is 176 LBS.

This instruction manual provides all the necessary information regarding:

- ▲ use of the refrigerator
- ▲ technical specifications
- ▲ installation and handling
- ▲ operator procedures and instructions
- ▲ maintenance operation

The manual is to be considered an integral part of the refrigerator and should be stored in a safe place for future consult to permit a good working life of the refrigerator.

The appliance is intended for commercial use only.

■ Component parts shall be replaced with like components and that servicing shall be done by factory authorized service personnel.

**The manufacturer cannot be held liable in the following cases:**

- improper installation (not in accordance with the guidelines indicated herein)
- misuse of the refrigerator
- power supply defects
- improper or inadequate maintenance
- unauthorised modification or tampering
- use of non-original spare parts
- partial or total failure to comply with the instructions

All electrical equipment can be hazardous to health. Current standards and legal requirements must be complied with during the installation and use of any equipment.



## 2. Use of the equipment

The refrigerator are for preserving fresh perishable foodstuffs, with an in-built refrigerated unit.

The operating temperature for refrigeration is:

- between 33°F and 45°F at room temperature of 109°F an 60%RD.

The operating temperature for frozen food maintenance is:

- between -8°F and -1°F at room temperature of 109°F an 60% RD.

## 3. Technical features

The refrigerator is a ventilated system, the evaporator is in a separate insulated box on the top. All the materials used in the manufacture of this unit are guaranteed to be suitable for use with foodstuffs. The gases used in produces is R290. The refrigerating circuit are in compliance with the current normative.

## 4. Operation

The gas in the refrigerating circuit is in the first time compressed, liquefied and then evaporated in the ventilated evaporator, situated on the top of the container.

This cycle involves the absorption of heath from the air in the refrigerator compartment and the reason is cooled. The heat produced is then dissipated to the outside environment by a condenser unit located on the top of the refrigerator.



## 5. Control unit

The refrigerator is command from a “digital control unit” and a “main switch pilot light” in the top panel of the refrigerator.

The “main switch pilot light” is for turning on the power supply.

The green pilot light comes on to indicate that the unit is connected to the main electricity and to start work.

The green pilot light comes off to indicate that the unit is disconnected and don’ t work. The “digital control unit” is for the regulation of all parameters to provide the correct working of the refrigerator. Please consult all parameters in the attachment manual of the “digital control unit”.

This manual is part of the instruction manual and is very important in case of service.

## 6. Handling

The refrigerator arrive in PET film and packed in cardboard box on a wood pallet.



The refrigerator must be transported and handled with care to avoid posing a hazard to persons or property.

Never place a refrigerator with an in-built refrigerated unit on its side or turn it upside

down as this may damage or impair operation of the refrigerated unit.

We can not held liable for any damage or defects arising directly or indirectly from improper handling of the equipment or non-compliance with the safeguards illustrated above.



## 7. Installation procedure

- ▲ Place the refrigerator in the coolest and best ventilated part of the room. Don't install the refrigerator in the near of heat and direct sunlight sources.
- ▲ Remove the straps securing the cardboard packing  
Remove the cardboard. Covering  
Remove the PET protection film
- ▲ Clean the refrigerator with mild detergent and then dry it with a soft cloth.

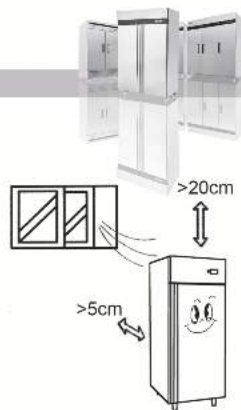

## 8. Connecting to the main power supply

-  This operation must be carried out by professionally and qualified persons.

The refrigerator are supplied complete with a power supply cable for the connection to the main power supply. A thermomagnetic circuit breaker (not supplied) must be installed between the mains power point and the power supply cable of the refrigerator.

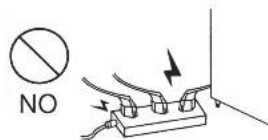

### Before proceeding make sure that:

- ▲ the mains voltage corresponds to the voltage on the refrigerator 115V/60Hz/1Ph; to ensure proper operation it is essential for the power supply voltage to come within a range of +/- 10% of the unit's rated voltage

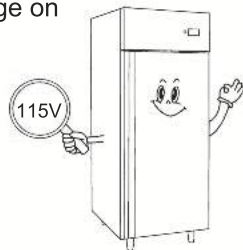



- ▲ the electric system to which the refrigerator is sized to cater for the rated electric output of the buffet unit being installed
- ▲ the electronic system to which the refrigerator is connected is made in compliance with current standard requirements
- ▲ the electric connections and the installation of the thermomagnetic circuit breaker have been done by qualified person.

### **Connecting steps:**

- ▲ Install a thermomagnetic circuit breaker suited to the rated output of the unit being installed
- ▲ Connect the refrigerator unit to the thermomagnetic circuit breaker outlet
- ▲ Check that the refrigerator is in order as demonstrated by the pilot light incorporated in the main switch coming on

## **9. Maintenance instructions**

The smooth operation and life of the equipment are mainly determined by correct and regular maintenance

### **Cleaning:**

Regular cleaning of the refrigerator unit is strongly recommended each month. Please follow the instructions below.



Disconnect the refrigerator power supply cable from the mains prior to carrying out any type of cleaning operation.

### **Cleaning the refrigerator surface:**

Clean the refrigerator with mild detergent and then dry it with a soft cloth.  
Do not use abrasive detergents!





### **Cleaning the inside of the refrigerator:**

Clean the inside area min. each month with a detergent suitable for use with foodstuffs.

### **Cleaning the condenser:**

For an efficient operation of the refrigerator it is advisable to clean the condenser regularly approx. every 4 months with a dry brush or vacuum cleaner.

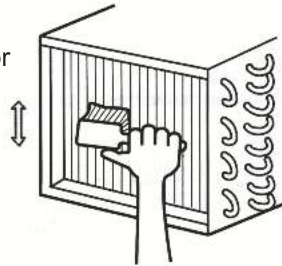

## **10. Troubleshooting**

Refrigerator stops working (light off):

☆ Power supply failure

▲ Remedies:

- ☆ Check that the plug is inserted properly in the socket
- ☆ Check that the switch on/off
- ☆ Check that the mains voltage powers the plug

Refrigerator temperature go up:

- ☆ Unit too near to a heat source
- ☆ Condenser dirty or close

▲ Remedies:

- ☆ Move the counter or the heat source further away
- ☆ Clean the condenser

## **11. Technical service**

For technical service please contact the dealer technical department and give him the serial n°, and the date of buy.



## 12. Configuration Sketch Map

### T Serise Reach-Ins

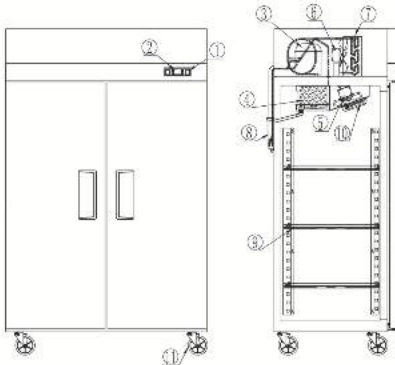

- |                 |                             |
|-----------------|-----------------------------|
| 1. Power switch | 2. Microcomputer controller |
| 4. Evaporator   | 5. Evaporator fan motor     |
| 7. Condenser    | 8. Drain case               |
| 10. Lamp        | 11. CASTER                  |

### B Serise Reach-Ins

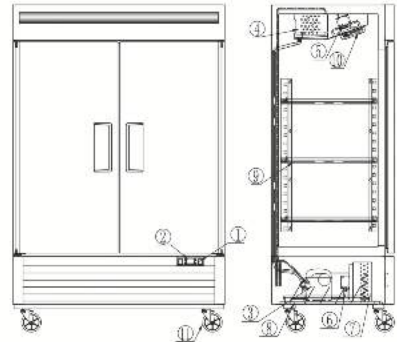

- |                        |
|------------------------|
| 3. Compressor          |
| 6. Condenser fan motor |
| 9. Shelf               |

## Operating Instruction



1. New upright air-cooling refrigerator should be opened and ventilate it before it is in use. After that, users should use warm water clean its inside.
2. After connecting the power supply, press the "POWER" switch on the controller keyboard (Green Indicator Light ON), the fridge will come to work. The microcomputer controller, installed in the controller keyboard, could automatically adjust the temperature ranges. This intelligent digital controller works as: if the temperature increases and reaches set point plus differential the compressor is started and then turned off when the temperature reaches the set point value again.



3. Microcomputer Controller Operation Instruction:

4. Microcomputer panel sketch map, meanings of running indicator light and LED showing.

5. **SET** To display target set point, in programming mode it selects a parameter or confirm an operation.



(Mod. XR06CX)

❄ To start a manual defrost.

▲ In programming mode it browses the parameter codes or increases the displayed value .

▼<sub>AUX</sub> In programming mode it browses the parameter codes or decreases the displayed value .

▼+▲ To lock or unlock the keyboard

**SET**+▼ To enter in programming mode

**SET**+▲ To return to room temperature display .

LED	MODE	SIGNIFICATO
❄	On	Compressor enabled
	Flashing	Anti short cycle delay enabled (AC parameter)
❄	On	Defrost in progress
	Flashing	Dripping in progress
🌀	On	Fans output enabled
	Flashing	Fans delay after defrost
°C	On	Measurement unit
	Flashing	Programming mode
°F	On	Measurement unit
	Flashing	Programming mode

6. How to see the point .

Push and immediately release the SET key, the set point will be showed;

Push and immediately release the SET key or wait about 5s to return to normal visualisation.

7. How to change the setpoint .

Push the SET key for more than 2 seconds to change the Set point value; The value of the set point will be displayed and the “°C” or “°F” LED starts blinking;

To change the Set value push the ▲ or ▼<sub>AUX</sub> arrows.

To memorise the new set point value push the SET key again or wait 10s.

8. How to start a manual defrost .

Push the DEF ❄ key for more than 2 seconds and a manual defrost will start .



## 9. How to change a parameter value

To change the parameter's value operate as follows:

Enter the Programming mode by pressing the **SET+▼** keys for 3s (“°C” or “°F” LED starts blinking).

Select the required parameter. Press the “SET” key to display its value

Use **▲** or **▼<sub>AUX</sub>** to change its value.

Press “SET” to store the new value and move to the following parameter.

To exit: Press **SET+▲** or wait 15s without pressing a key.

NOTE: the set value is stored even when the procedure is exited by waiting the time-out to expire.

## 10. To lock the keyboard .

Keep pressed for more than 3s the **▼+▲** keys.

The “OF” message will be displayed and the keyboard will be locked.

If a key is pressed more than 3s the “OF” message will be displayed.

## 11. To unlock the keyboard .

Keep pressed together for more than 3s the **▼+▲** keys till the “on” message will be displayed .

## 12. Alarm signalling .

Mess.	Cause	Outputs
"P1"	Room probe failure	Compressor output according to "Cy" e "Cn"
"P2"	Evaporator probe failure	Defrost end is timed
"HA"	Maximum temperature alarm	Outputs unchanged
"LA"	Minimum temperature alarm	Outputs unchanged
"EA"	External alarm	Outputs unchanged
"CA"	Serious external alarm	All outputs OFF
"dA"	Door Open	Compressor and fans restarts



Our products have been modified precisely before leaving factory, so to avoid damaging compressor unit or other malfunctions, users mustn't modify the microcomputer parameters privately.

## Electrical Control Circuit Diagram

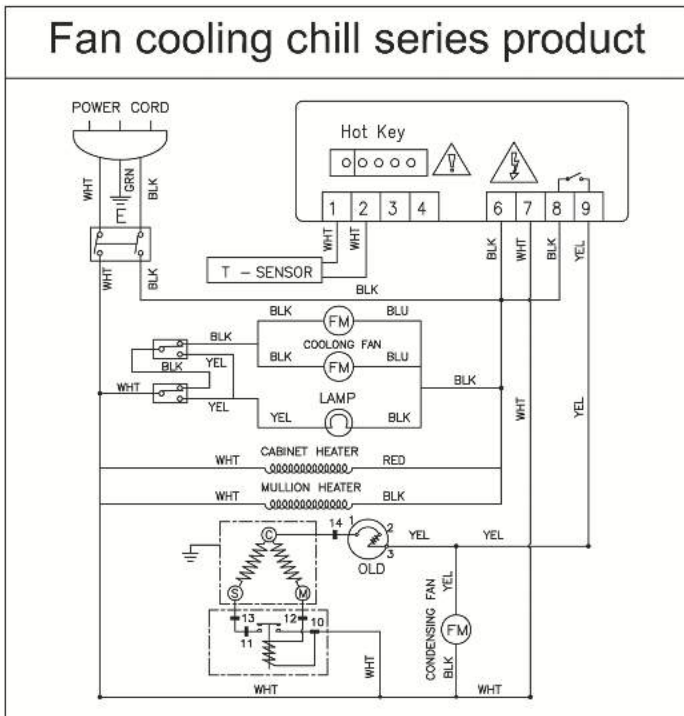



## Fan cooling freeze series product

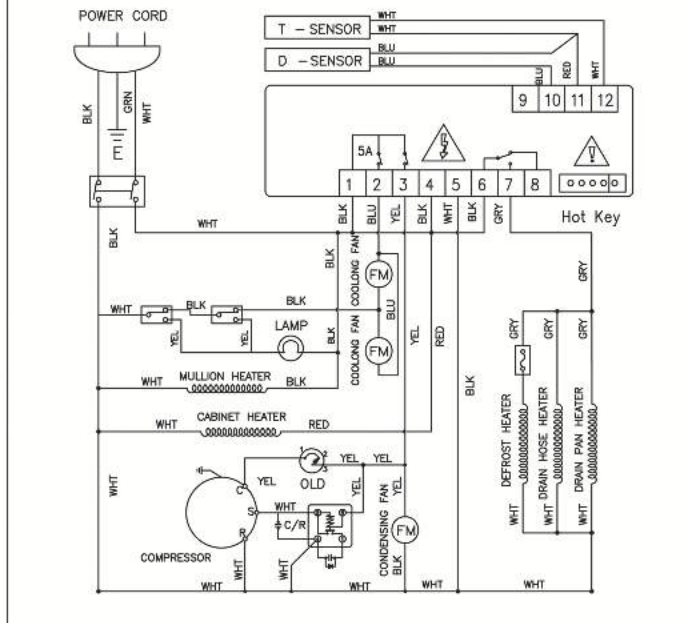



## Technical Parameters

### T Series Reach-Ins

<b>Model code</b>	<b>Power source (V)</b>	<b>Rating frequency(Hz)</b>	<b>Input power (w)</b>	<b>Rated current(A)</b>	<b>Temperature range (°F)</b>	<b>Refrigerant</b>	<b>Amount(oz)</b>	<b>Dimension (in)</b>	<b>Volume (cu.ft)</b>
C-1F-HC	115	60	610	6.3	-8~-1	R290	4.2	28.7×33.3×81.3	21.4
C-2F-HC	115	60	935	8.6	-8~-1	R290	5.3	51.7×33.3×81.3	43.16
C-1R-HC	115	60	250	2.1	+33~+45	R290	3.9	28.7×33.3×81.3	21.4
C-2R-HC	115	60	370	3.2	+33~+45	R290	4.9	51.7×33.3×81.3	43.16
C-3R-HC	115	60	470	4.2	+33~+45	R290	5.3	77.8×33.3×81.3	64.88

**NOTES :**

If the technical data has any changes, we will not notify you any longer.



## B Series Reach-Ins

<b>Model code</b>	<b>Power source (V)</b>	<b>Rating frequency(Hz)</b>	<b>Input power (w)</b>	<b>Rated current(A)</b>	<b>Temperature range (°F)</b>	<b>Refrigerant</b>	<b>Amount(oz)</b>	<b>Dimension (in)</b>	<b>Volume (cu.ft)</b>
C-1FB-HC	115	60	610	6.3	-8~-1	R290	4.2	27×31.5×84	19.1
C-2FB-HC	115	60	935	8.6	-8~-1	R290	5.3	39.5×31.5×84	30.2
C-2FB-HC	115	60	935	8.6	-8~-1	R290	5.3	54.5×31.5×84	44.77
C-1FB-HC	115	60	250	2.1	+33~+45	R290	3.9	27×31.5×84	19.1
C-2FB-HC	115	60	370	3.2	+33~+45	R290	4.9	39.5×31.5×84	30.2
C-2FB-HC	115	60	370	3.2	+33~+45	R290	4.9	54.5×31.5×84	44.77
C-3RB-HC	115	60	470	4.2	+33~+45	R290	5.3	81.85×31.5×84	67.99

### NOTES :

If the technical data has any changes, we will not notify you any longer.



## OFFICIAL APPROVAL AND RULES

CONFORMS TO UL STD.471

CERTIFIED TO CSA STD.C22.2 NO.120

CONFORMS TO NSF/ANSI STD. 7



---

**Intertek**  
4003935  
CONFORMS TO UL STD.471  
CERTIFIED TO CSA STD.C22.2 NO.120



---

**Intertek**  
4003935  
CONFORMS TO NSF/ANSI STD.7

W081109601.20170511

